

Giunti a Scatto
Snap Fittings

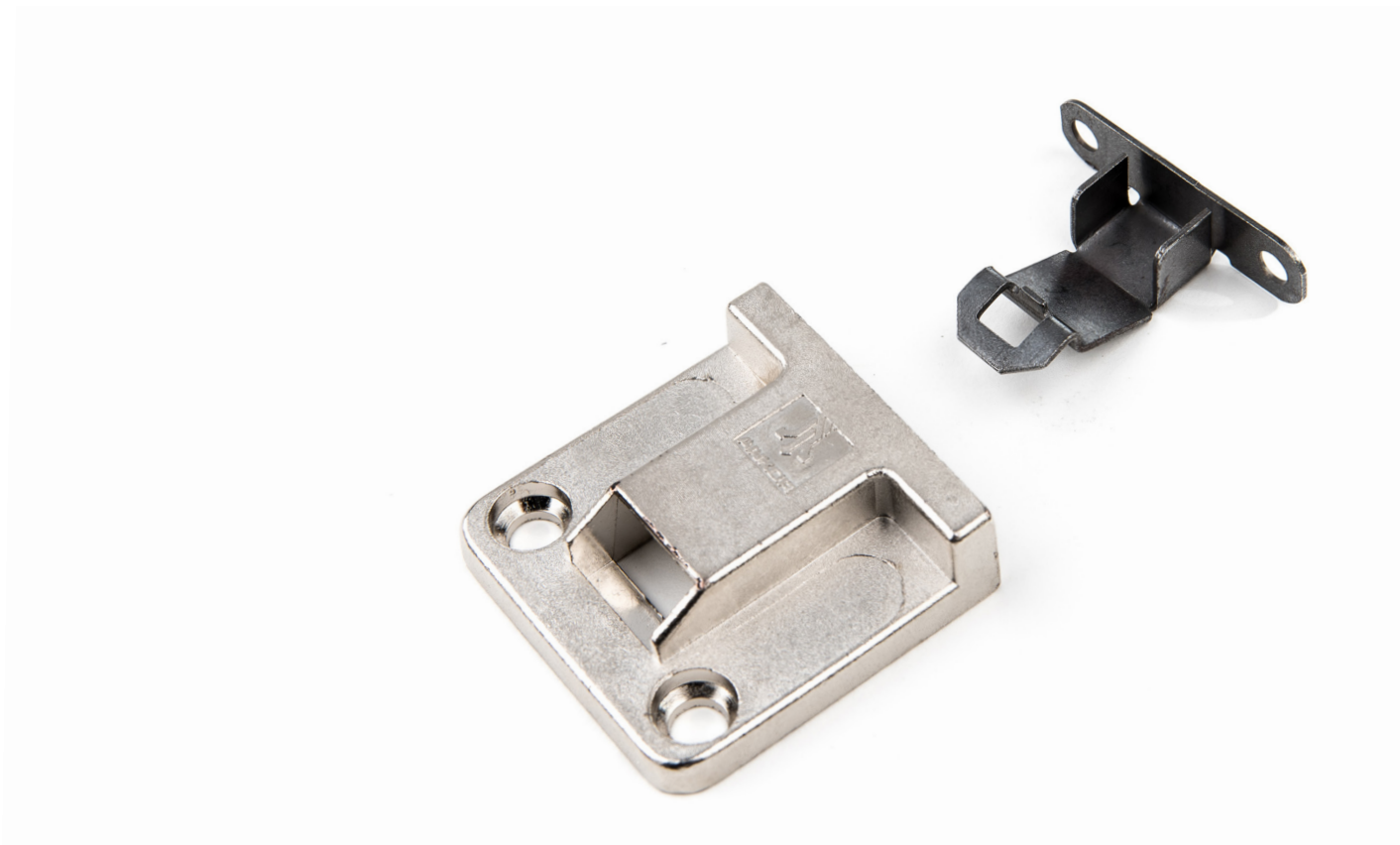

Normal 680

Fermaschiena
Panel Fastener

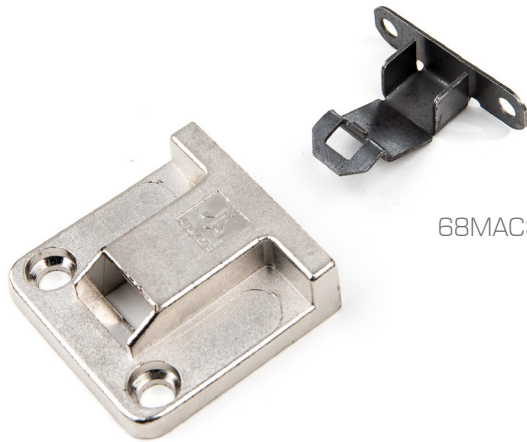

68MAC320035

68SXX370036

Fermaschiena ad inserimento a scatto molto robusto, progettato per schiene di grande spessore. Si abbina alla sua molla d'acciaio. Progettato per fissare il pannello a scatto con un solo gesto. Materiali: Zama, Acciaio. Finitura: Nichelata. Pz per scatola: 1000.

Very strong snap fitting designed to fix thick furniture's back panels to the furniture. It is combined with its steel spring. Designed to fix the panel with just one gesture. Materials: Zama, Steel. Finishing: Nickel Plated. Pcs perbox: 1000.

Foratura spalla
Side panel's drilling

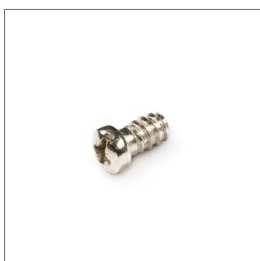
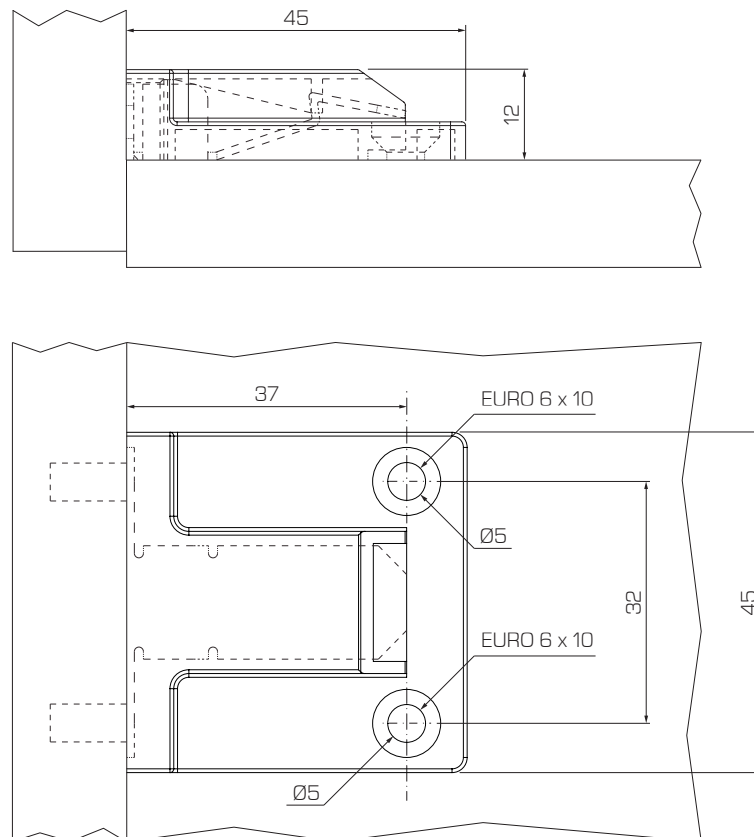

Vite EURO
EURO screw

VTXTPEU1036

Foratura schiena
Back panel's drilling

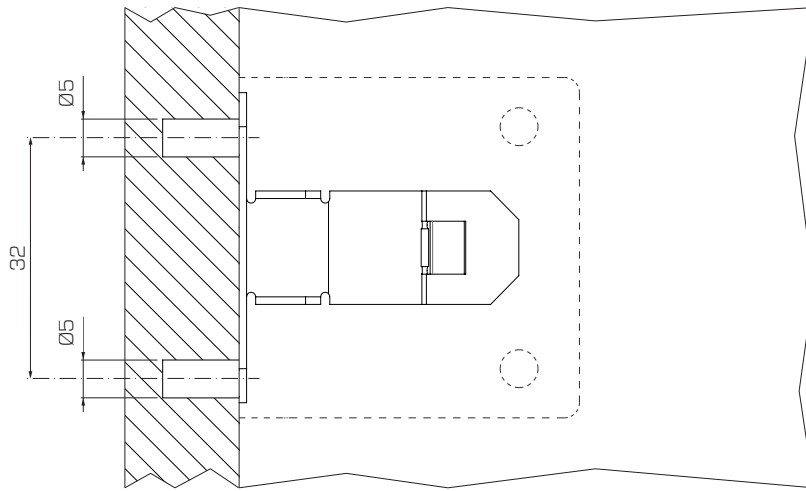

Vite 12 mm
12 mm screw
VTXTSO41236

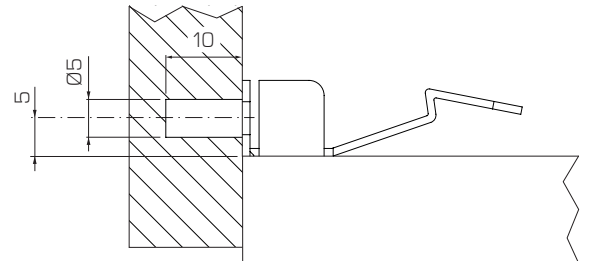
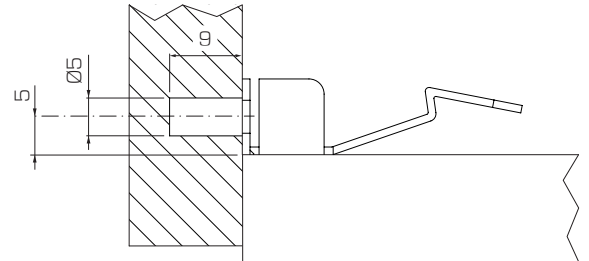

Normal 720

Fermaschiena
Panel Fastener



Molla di acciaio progettata per il fissaggio della zoccolatura dei mobili. Disponibile in diverse dimensioni: 9, 16,5, 20 and 37 mm. Materiale: Acciaio. Finitura: Brunita. Pz per scatola: 2000.

Steel springs used to fix baseboards to the furniture. Available in different axle spacing sizes: 9, 16,5, 20 and 37 mm. Material: Steel. Finishing: Burnished. Pcs per box: 2000.

Foratura Drilling

Modello chiuso
Closed model

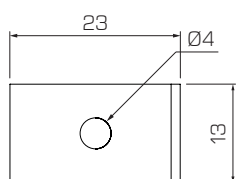

| l | Cod. |
|------|-------------|
| 16,5 | 72XAC165035 |
| 20 | 72XAC200035 |
| 37 | 72XAC370035 |

Modello aperto
Open model

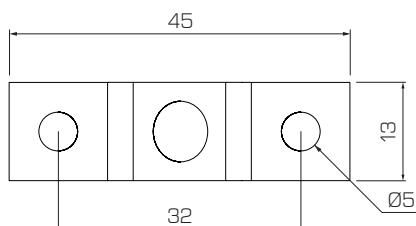

| l | Cod. |
|---|-------------|
| 9 | 72XAC090035 |

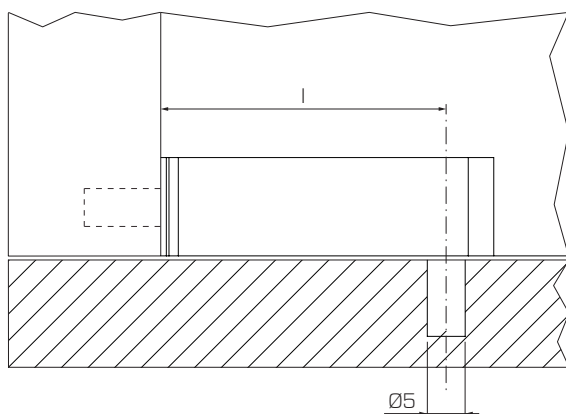

Perno mordente legno
Thread cutting pin

7XPML051031

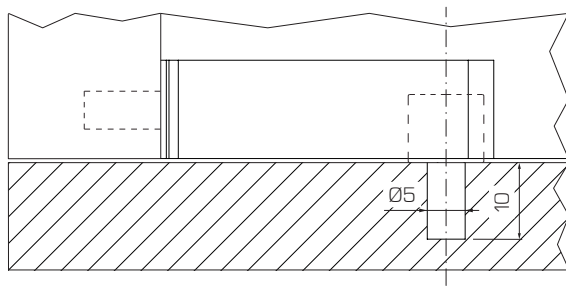

Perno con flangia
Pin with collar

7XPMT05FE31

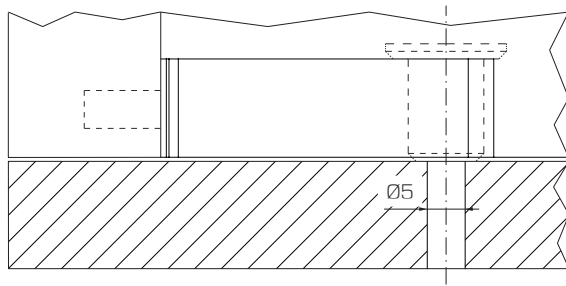

Normal 800 - Normal 850

Spine a Scatto Plug Snap Fittings



Spine a scatto progettate per il fissaggio non strutturale di frontalini e listelli di finitura sul mobile. Normal 850 è progettata per il montaggio perpendicolare.

Progettate per essere abbinata alle bussole nelle quali vengono inserite.

Materiale: Acetalica. Colore Normal 800: Nero. Colore Normal 850: Bianco. Pz per scatola: 1000.

Plug snap fittings designed for the non structural fixing of front panels and finishing listels on furniture. Normal 850 is designed for perpendicular mounting.

Designed to be combined with dowels in which are inserted.

Material: Acetal. Normal 800 Colour: Black. Normal 850 Colour: White. Pcs per box: 1000.

Foratura Drilling



85MPL000001



BXXPL121101



80MPL000002



BXXPL121102

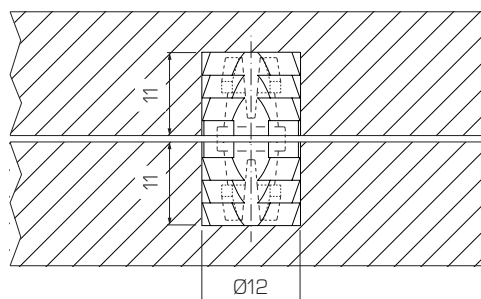
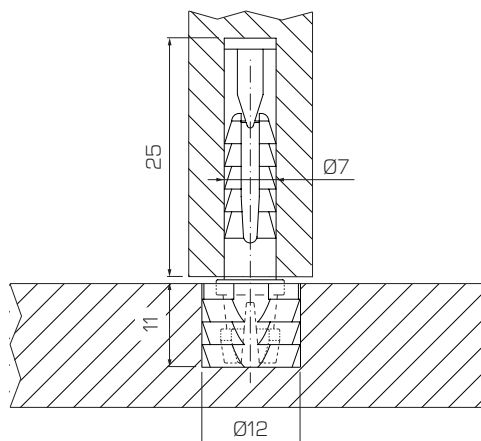

Il catalogo di Effegibrevetti contiene:

- Aperture a Ribalta
- Aperture a Pacchetto
- Aperture Verticali
- Aperture Oblique
- Apertura a Pantografo
- Aperture Scorrevoli Complanari
- Aperture Scorrevoli
- Cerniere
- Bussole a Espansione
- Giunti Orizzontali
- Giunti Verticali
- Giunti a Scatto
- Reggipiani
- Livellatori
- Push to Open

*Effegibrevetti ha la facoltà di apportare ai prodotti tutte le modifiche e migliorie tecniche.

Effegibrevetti's catalog contains:

- Flap Openings
- Folding Openings
- Vertical Openings
- Oblique Openings
- Pantograph Openings
- Coplanar Sliding Mechanisms
- Standard Sliding Mechanisms
- Hinges
- Spreading Dowels
- Horizontal Fittings
- Vertical Fittings
- Snap Fittings
- Shelf Supports
- Levellers
- Push to Open

*Effegibrevetti reserve the right to make changes and technical improvements to its products.

EFFEGIBREVETTI

Effegibrevetti S.r.l.

Via Cava Trombetta 17/25
20090 Segrate Milano Italy

Tel +39 02 26921838
Fax +39 02 26921737

info@effegibrevetti.com
www.effegibrevetti.com

**COMPANY WITH
QUALITY SYSTEM
CERTIFIED BY DNV GL
= ISO 9001 =**